

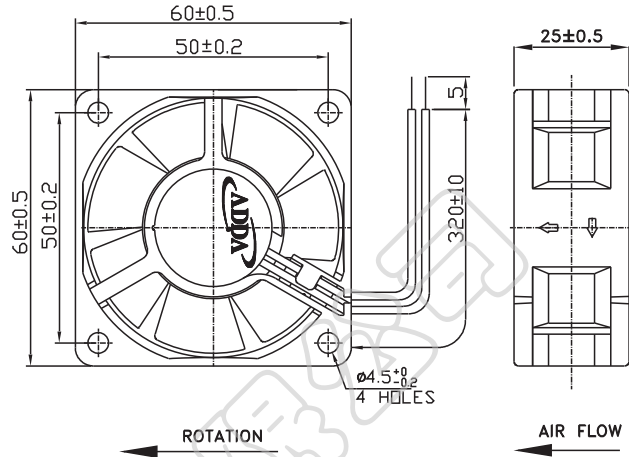

AD6025 SERIES



External Dimensions



Frame: Plastic (UL:94V-0)
 Impeller: Plastic (UL:94V-0)
 Lead wire: UL1007AWG24

Specifications (Nominal)

*Noise is measured at the distance of one (1) meter from the axis of intake.

Bearing type: ⊙=Ball ※=Sleeve ○=1B1S ●=Hypro bearing

Frame size (mm)	Model No.	Bearing System Type	Rated Voltage (VDC)	Current (A)	Power (W)	Rated Speed (rpm)	Maximum AirFlow (CMM)	Maximum AirFlow (CFM)	Maximum Pressure (InAq)	Maximum Pressure (mmAq)	*Noise Level (dB/A)	Weight (g)
60x60x25	AD0605LB-A71GL	⊙ ※ ●	5	0.08	0.40	2500	0.373	13.200	0.063	1.600	18.1	53.0
	AD0605MB-A71GL	⊙ ※ ●	5	0.17	0.85	3500	0.506	17.880	0.125	3.175	27.9	
	AD0605HB-A71GL	⊙ ※ ●	5	0.35	1.75	4500	0.688	24.330	0.207	5.257	36.3	
	AD0612LB-A71GL	⊙ ※ ●	12	0.04	0.48	2500	0.373	13.200	0.063	1.600	18.1	
	AD0612MB-A71GL	⊙ ※ ●	12	0.08	0.96	3500	0.506	17.880	0.125	3.175	27.9	
	AD0612HB-A71GL	⊙ ※ ●	12	0.13	1.56	4500	0.688	24.330	0.207	5.257	36.3	
	AD0612UB-A71GL	⊙ ※ ●	12	0.21	2.52	5000	0.789	27.880	0.242	6.146	37.6	
	AD0612XB-A71GL	⊙	12	0.30	3.60	6100	0.888	31.400	0.320	8.128	42.9	
	AD0624LB-A71GL	⊙ ※ ●	24	0.07	1.68	2500	0.373	13.200	0.063	1.600	18.1	
	AD0624MB-A71GL	⊙ ※ ●	24	0.06	1.44	3500	0.506	17.880	0.125	3.175	27.9	
	AD0624HB-A71GL	⊙ ※ ●	24	0.08	2.88	4500	0.688	24.330	0.207	5.257	36.3	
	AD0624UB-A71GL	⊙ ※ ●	24	0.10	2.40	5000	0.789	27.880	0.242	6.146	37.6	

Specifications subject to change without notice.

The specification for bearing type is for reference only, for more bearing types information, please contact with your ADDA sales representative, thanks!!
 (網頁上呈現產品軸承資訊均以2Ball為主, 若需其他產品資訊請聯絡您在ADDA的業務代表, 謝謝!!)

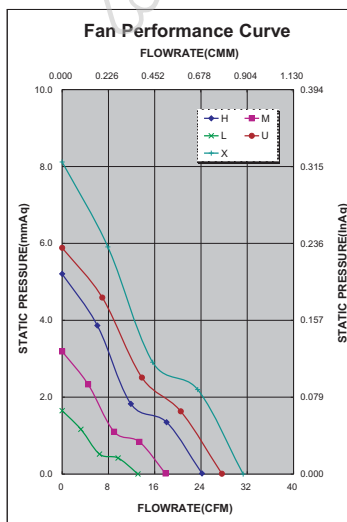

*Motor protective circuit and third lead wire functions

0	1	2	3	4	6	7	8	9	A	B
	✓	✓	✓	✓			✓	✓	✓	✓

*Safety approvals

✓	✓		✓	✓